

JVC



MICRO COMPONENT SYSTEM

微型组合音响

UX-P3 — Consists of CA-UXP3 and SP-UXP3.

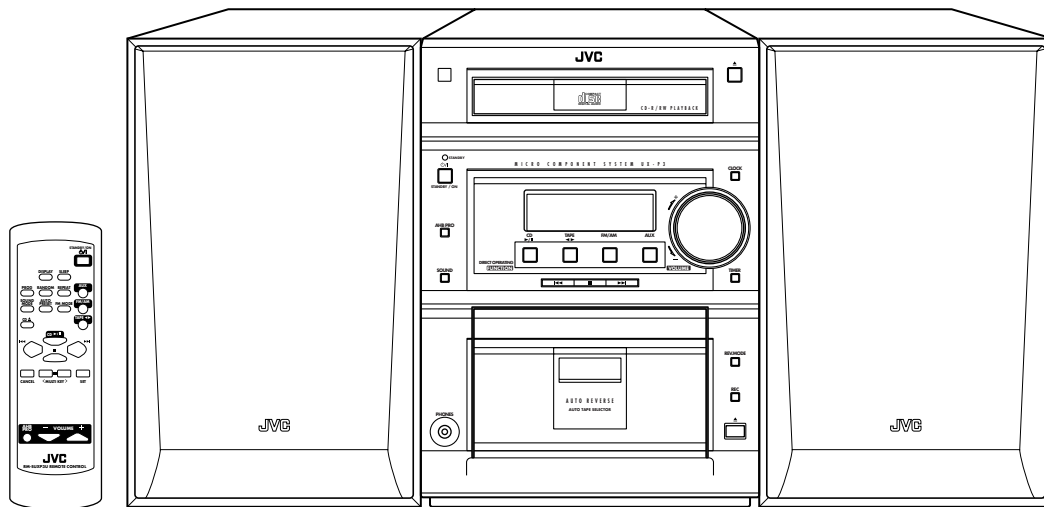

COMPACT
disc
DIGITAL AUDIO

INSTRUCTIONS 使用说明书

For Customer Use:

Enter below the Model No. and Serial No. which are located either on the rear, bottom or side of the cabinet. Retain this information for future reference.

Model No. _____

Serial No. _____

GVT0053-014A
[UB]

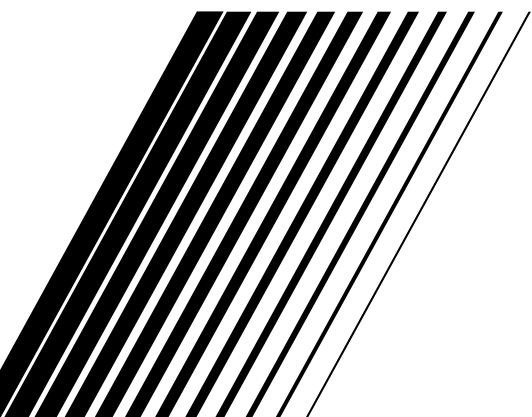

Warnings, Cautions and Others

警告，注意及其他须知事项

Caution — 电源开关!

Disconnect the mains plug to shut the power off completely. The 电源开关 button in any position does not disconnect the mains line. The power can be remote controlled.

注意— 电源开关!

无论 电源开关 开关在任何位置，电源线的电源还是没有被切断，若要将电源完全关闭，应把电源插头拔离插座。电源开关可用遥控器控制。

CAUTION

To reduce the risk of electrical shocks, fire, etc.:

1. Do not remove screws, covers or cabinet.
2. Do not expose this appliance to rain or moisture.

CAUTION

- Do not block the ventilation openings or holes. (If the ventilation openings or holes are blocked by a newspaper or cloth, etc., the heat may not be able to get out.)
- Do not place any naked flame sources, such as lighted candles, on the apparatus.
- When discarding batteries, environmental problems must be considered and local rules or laws governing the disposal of these batteries must be followed strictly.
- Do not use this apparatus in a bathroom or places with water. Also do not place any containers filled with water or liquids (such as cosmetics or medicines, flower vases, potted plants, cups, etc.) on top of this apparatus.

警告

为了减低触电，火灾等危险：

1. 请勿擅自卸下螺丝钉，盖子或机壳。
2. 切勿让本机受雨淋或置潮湿环境中。

注意

- 请勿堵塞通风口或通风孔。
(如果通风口或通风孔被报纸或布等堵塞，热量将无法散出。)
- 请勿在本设备上放置任何裸露的火源，如点燃的蜡烛。
- 处理废弃电池时，必须考虑环境问题，并严格遵守当地关于处理废弃电池的有关法律或规定。
- 请勿在浴室里或有水汽的地方使用本设备。亦请勿在本设备的上方放置任何装有水或液体的容器（如化妆品，药品，花瓶，花盆，杯子等）。

Caution: Proper Ventilation

To avoid risk of electric shock and fire, and to prevent damage, locate the apparatus as follows:

1 Front:

No obstructions and open spacing.

2 Sides/ Top/ Back:

No obstructions should be placed in the areas shown by the dimensions below.

3 Bottom:

Place on the level surface. Maintain an adequate air path for ventilation by placing on a stand with a height of 10 cm or more.

注意：正确通风

为免发生触电和火警的危险，及防止本机受损，请将本机如下放置：

1. 前面： 没有障碍物及地方开阔。

2. 侧面/顶面/背面： 在图中所示范围中，不应放置任何障碍物。

3. 底部： 放置在水平面上。放置在一个高 10 厘米或以上的台上，以保持足够的通风道。

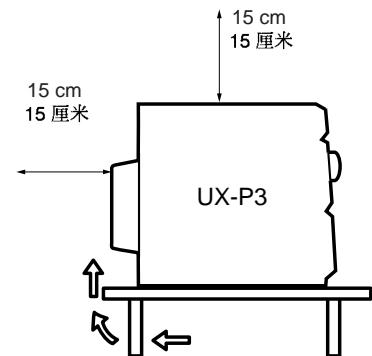
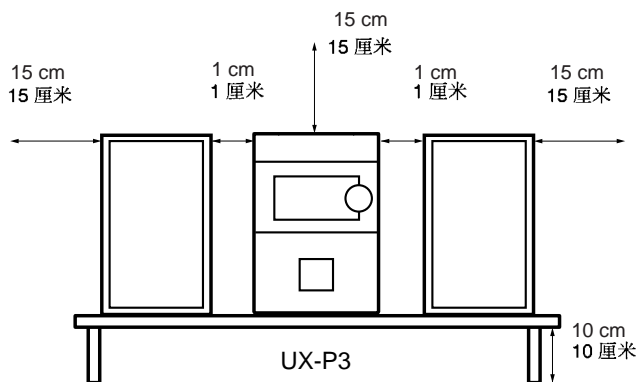

IMPORTANT FOR LASER PRODUCTS

雷射产品的重要说明

REPRODUCTION OF LABELS / 标签内容说明

- ① CLASSIFICATION LABEL, PLACED ON REAR ENCLOSURE ② WARNING LABEL, PLACED INSIDE THE UNIT

① 分类标签，贴在机壳背后

② 警告标签，贴于机内

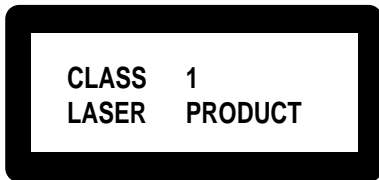

CAUTION: Invisible laser radiation when open and interlock failed or defeated. AVOID DIRECT EXPOSURE TO BEAM. (e)

ADVARSEL: Usynlig laserstråling ved åbning, når sikkerhedsafbrydere er ude af funktion. Undgå udsættelse for stråling (d)

WARNING: Osynlig laserstråling när denna del är öppnad och spårren är urkopplad. Betrakta ej strålen. (s)

VARO: Avattaessa ja suo-
jalukitus ohitettaessa olet
alittiina näkymättömälle
lasersäteilylle. Älä katso
säteeseen. (f)

-
1. CLASS 1 LASER PRODUCT
 2. **CAUTION:** Invisible laser radiation when open and interlock failed or defeated. Avoid direct exposure to beam.
 3. **CAUTION:** Do not open the top cover. There are no user serviceable parts inside the Unit; leave all servicing to qualified service personnel.

1. 一级雷射产品
2. **注意：**当内部锁定装置失效或者损坏后，打开盖板可能会产生不可见的雷射辐射。应避免受到光束直接照射。
3. **注意：**请勿打开顶盖板。本机内部没有用户可自行维修的部件；所有维修工作应由有资格的人员完成。

Introduction

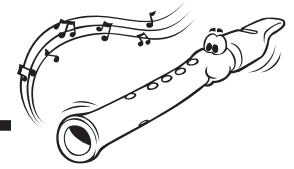

We would like to thank you for purchasing one of our JVC products. Before operating this unit, read this manual carefully and thoroughly to obtain the best possible performance from your unit, and retain this manual for future reference.

About This Manual

This manual is organized as follows:

- **The manual mainly explains operations using the buttons on the remote control. You can use the buttons both on the remote control and on the unit for the same operations if they have the same or similar names (or marks), unless mentioned otherwise.**
- Basic and common information that is the same for many functions is grouped in one place, and is not repeated in each procedure. For instance, we do not repeat the information about turning on/off the unit, setting the volume, changing the sound effects, and others, which are explained in the section “Common Operations” on pages 9 and 10.
- The following marks are used in this manual:



Gives you warnings and cautions to prevent from damage or risk of fire/electric shock. Also gives you information which is not good for obtaining the best possible performance from the unit.



Gives you information and hints you had better know.

Precautions

Installation

- Install in a place which is level, dry and neither too hot nor too cold — between 5°C (41°F) and 35°C (95°F).
- Install the unit in a location with adequate ventilation to prevent internal heat built-up in the unit.
- Leave sufficient distance between the unit and the TV.
- Keep the speakers away from the TV to avoid interference with TV.



DO NOT install the unit in a location near heat sources, or in a place subject to direct sunlight, excessive dust or vibration.

Power sources

- When unplugging from the wall outlet, always pull the plug, not the AC power cord.



DO NOT handle the AC power cord with wet hands.

Moisture condensation

Moisture may condense on the lens inside the unit in the following cases:

- After starting heating in the room
 - In a damp room
 - If the unit is brought directly from a cold to a warm place
- Should this occur, the unit may malfunction. In this case, leave the unit turned on for a few hours until the moisture evaporates, unplug the AC power cord, and then plug it in again.

Others

- Should any metallic object or liquid fall into the unit, unplug the unit and consult your dealer before operating any further.
- If you are not going to operate the unit for an extended period of time, unplug the AC power cord from the wall outlet.



DO NOT disassemble the unit since there are no user serviceable parts inside.

If anything goes wrong, unplug the AC power cord and consult your dealer.

Contents

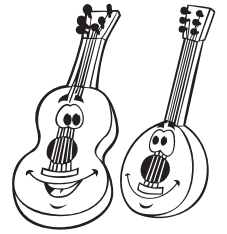

Location of the Buttons and Controls	3	Playing Back CDs (CD/CD-R/CD-RW)	12
Front Panel	3	Playing Back the Entire CD — Normal Play	12
Remote Control	5	Basic CD Operations	12
Getting Started	6	Programming the Playing Order of the Tracks — Program Play	13
Supplied Accessories	6	Playing at Random — Random Play	14
Putting the Batteries into the Remote Control	6	Repeating Tracks — Repeat Play	14
Connecting Antennas	6	Prohibiting Disc Ejection — Tray Lock	14
Connecting Speakers	7	Playing Back Tapes	15
Connecting Other Equipment	8	Playing Back a Tape	15
Common Operations	9	Recording	16
Turning On the Power	9	Recording on a Tape	16
Setting the Clock	9	CD Direct Recording	17
Setting the AM Tuner Interval Spacing	9	One Track Recording	17
Selecting the Sources and Starting Play	10	Using the Timers	18
Adjusting the Volume	10	Using Daily Timer and Recording Timer	18
Reinforcing the Bass Sound	10	Using Sleep Timer	19
Selecting the Sound Modes	10	Maintenance	20
Listening to FM and AM Broadcasts	11	Troubleshooting	21
Tuning in a Station	11	Specifications	22
Presetting Stations	11		
Tuning in a Preset Station	11		

Location of the Buttons and Controls

Become familiar with the buttons and controls on your unit.

Front Panel

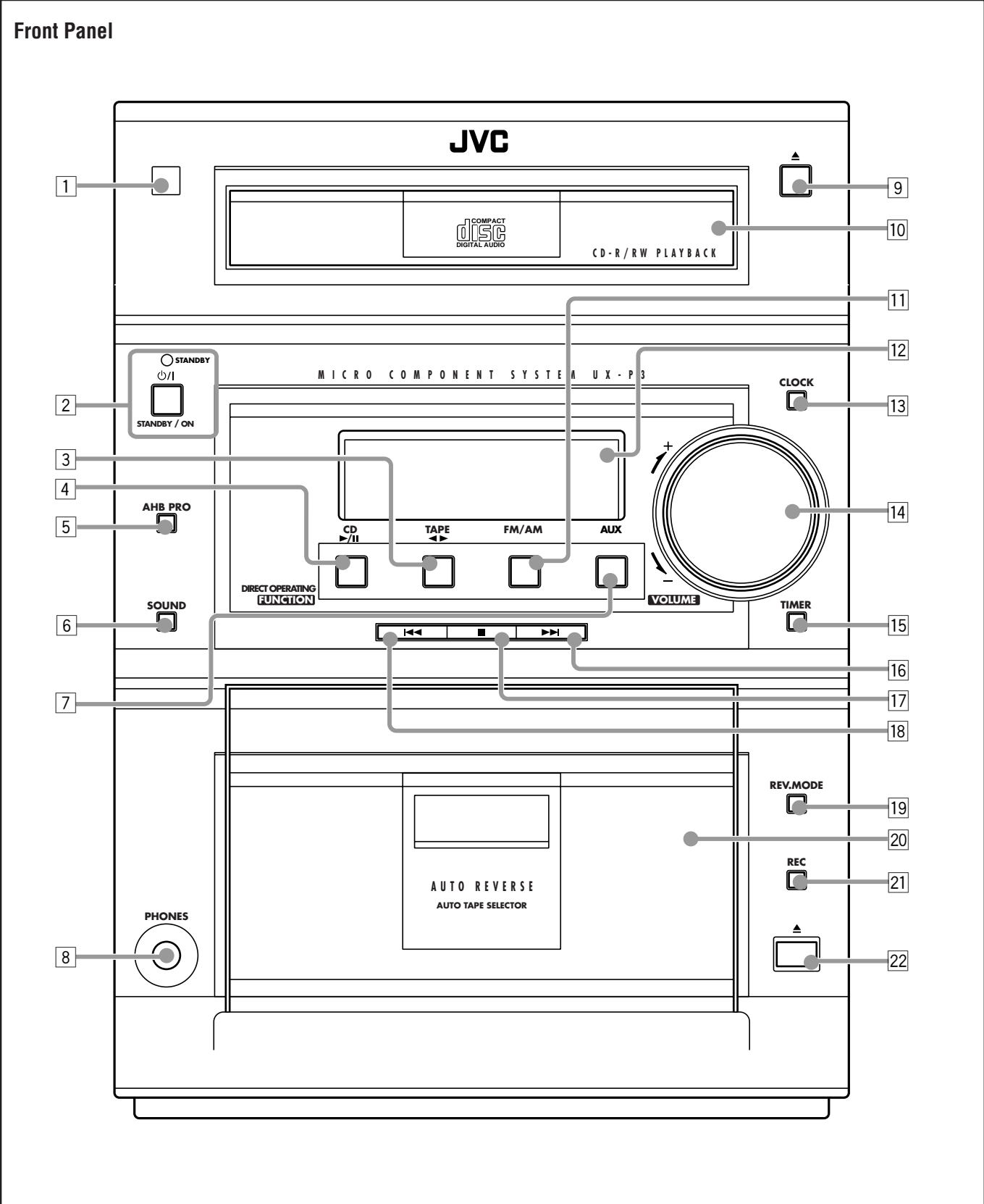

Display Window

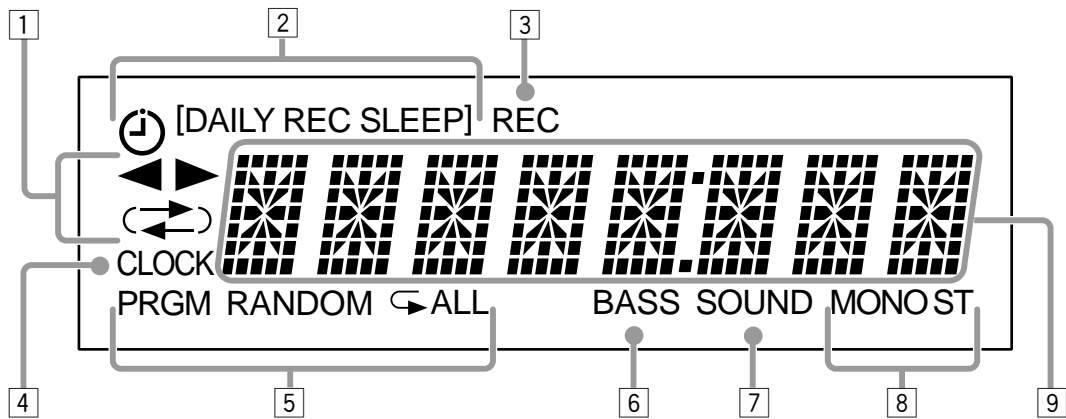

See pages in the parentheses for details.

Front Panel

- 1 Remote sensor
- 2 \odot/I (STANDBY/ON) button and STANDBY lamp (9, 14, 19)
- 3 TAPE $\blacktriangleleft\blacktriangleright$ button (10, 15, 16)
Pressing this button also turns on the unit.
- 4 CD $\blacktriangleright/\text{II}$ (play/pause) button (10, 12, 17)
Pressing this button also turns on the unit.
- 5 AHB (Active Hyper Bass) PRO button (10)
- 6 SOUND button (10)
- 7 AUX button (10)
Pressing this button also turns on the unit.
- 8 PHONES jack (10)
- 9 \blacktriangle (disc tray open/close) button (12)
Pressing this button also turns on the unit.
- 10 Disc tray
- 11 FM/AM button (10, 11)
Pressing this button also turns on the unit.
- 12 Display window
- 13 CLOCK button (9)
- 14 VOLUME + / - control (10)
- 15 TIMER button (18, 19)
- 16 $\blacktriangleright\blacktriangleright\text{I}$ (forward search) button (9, 11, 12, 14, 15, 18)
- 17 \blacksquare (stop) button (12 – 17)
- 18 $\blacktriangleleft\blacktriangleleft$ (reverse search) button (9, 11, 12, 15, 18)
- 19 REV.MODE (reverse mode) button (15 – 17)
- 20 Cassette holder
- 21 REC button (16, 17)
- 22 \blacktriangle (eject) button for cassette deck (15 – 17)

Display Window

- 1 Tape operation indicators
 - $\blacktriangleleft\blacktriangleright$ (tape direction) and $\blacktriangleleft\blacktriangleright$ (reverse mode) indicators
- 2 Timer indicators
 - \odot (timer), DAILY, REC and SLEEP indicators
- 3 REC indicator
- 4 CLOCK indicator
- 5 CD play mode indicators
 - PRGM (program), RANDOM and repeat ($\blacktriangleleft/\blacktriangleright$ ALL) indicators
- 6 BASS (Active Hyper Bass) indicator
- 7 SOUND (sound mode) indicator
- 8 Tuner operation indicators
 - MONO and ST (stereo) indicators
- 9 Main display
 - Shows the source name, frequency, etc.



Remote Control

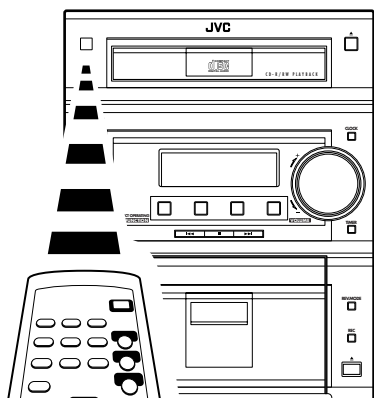
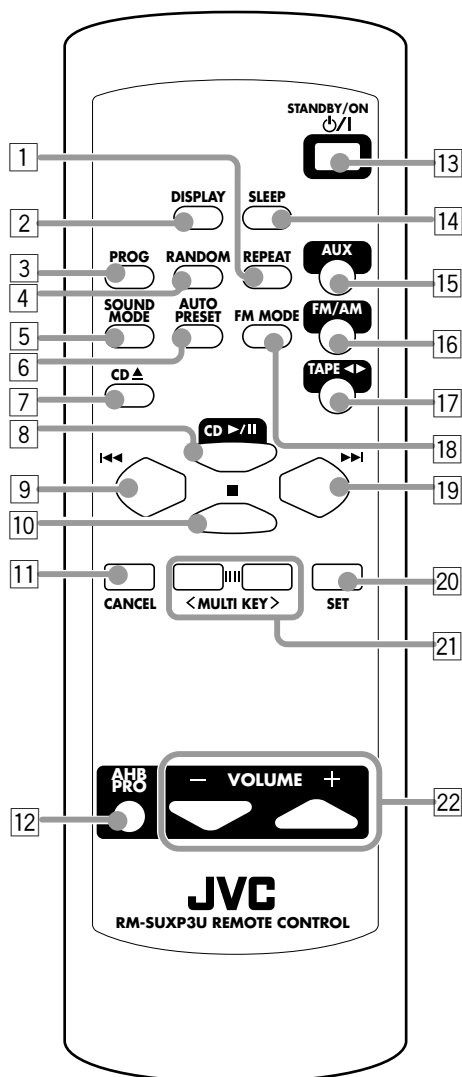

When using the remote control, point it at the remote sensor on the front panel.

Remote Control

- 1 REPEAT button (14)
- 2 DISPLAY button (9)
- 3 PROG (program) button (13)
- 4 RANDOM button (14)
- 5 SOUND MODE button (10)
- 6 AUTO PRESET button (11)
- 7 CD ▲ (disc tray open/close) button (12)
Pressing this button also turns on the unit.
- 8 CD ►/|| button (10, 12, 13)
Pressing this button also turns on the unit.
- 9 ◀◀ (reverse search) button (11, 12, 15)
- 10 ■ (stop) button (12 – 17)
- 11 CANCEL button (13)
- 12 AHB (Active Hyper Bass) PRO button (10)
- 13 ⏻ (STANDBY/ON) button (9)
- 14 SLEEP button (19)
- 15 AUX button (10)
Pressing this button also turns on the unit.
- 16 FM/AM button (10, 11)
Pressing this button also turns on the unit.
- 17 TAPE ◀▶ button (10, 15)
Pressing this button also turns on the unit.
- 18 FM MODE button (11)
- 19 ▶▶ (forward search) button (11, 12, 14, 15)
- 20 SET button (11, 13)
- 21 MULTI KEY > / < buttons (11 – 14)
- 22 VOLUME + / - buttons (10)

Supplied Accessories

Make sure that you have all the following items. The number in the parentheses indicates the quantity of the pieces supplied.

- AM loop antenna (1)
- FM antenna (1)
- Remote control (1)
- Batteries (2)

If anything is missing, consult your dealer immediately.

Putting the Batteries into the Remote Control

Insert the batteries — R6(SUM-3)/AA(15F) — into the remote control, by matching the polarity (+ and –) on the batteries with the + and – markings on the battery compartment.

When the remote control can no longer operate the unit, replace both batteries at the same time.

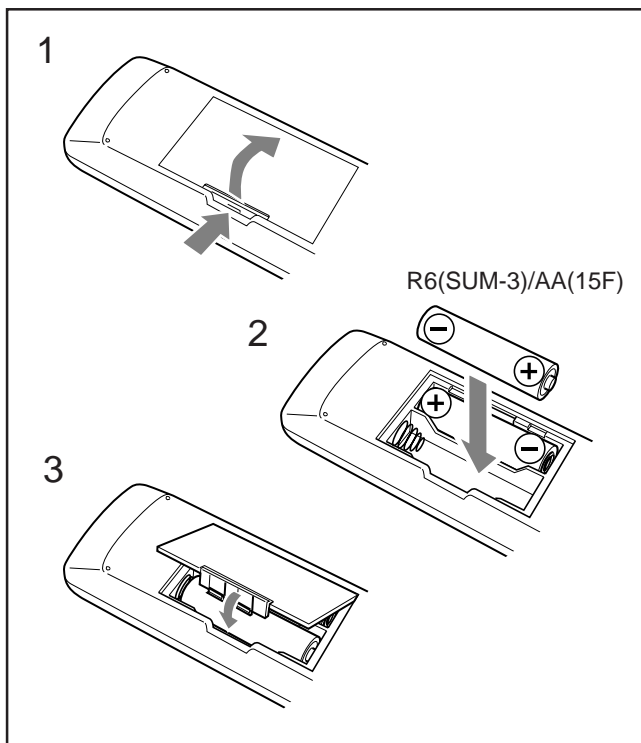

- DO NOT use an old battery together with a new one.
- DO NOT use different types of batteries together.
- DO NOT expose batteries to heat or flame.
- DO NOT leave the batteries in the battery compartment when you are not going to use the remote control for an extended period of time. Otherwise, it will be damaged from battery leakage.

Connecting Antennas

FM antenna

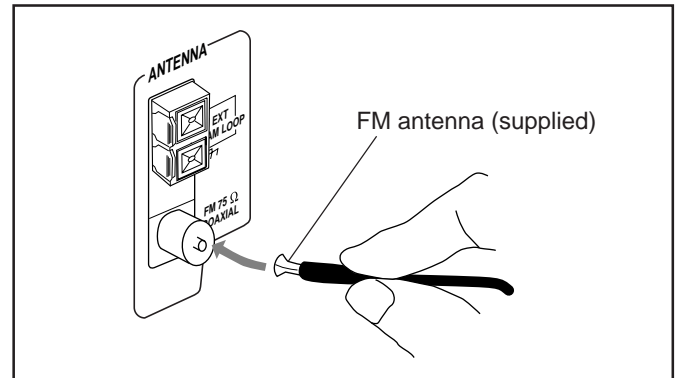

- 1 Attach the FM antenna to the FM 75 Ω COAXIAL terminal.
- 2 Extend the FM antenna.
- 3 Fasten it up in the position which gives you the best reception, then fix it on the wall, etc.



About the supplied FM antenna

The FM antenna supplied with this unit can be used as temporary measure. If reception is poor, you can connect an outdoor FM antenna.

To connect an outdoor FM antenna

Before connecting it, disconnect the supplied FM antenna.

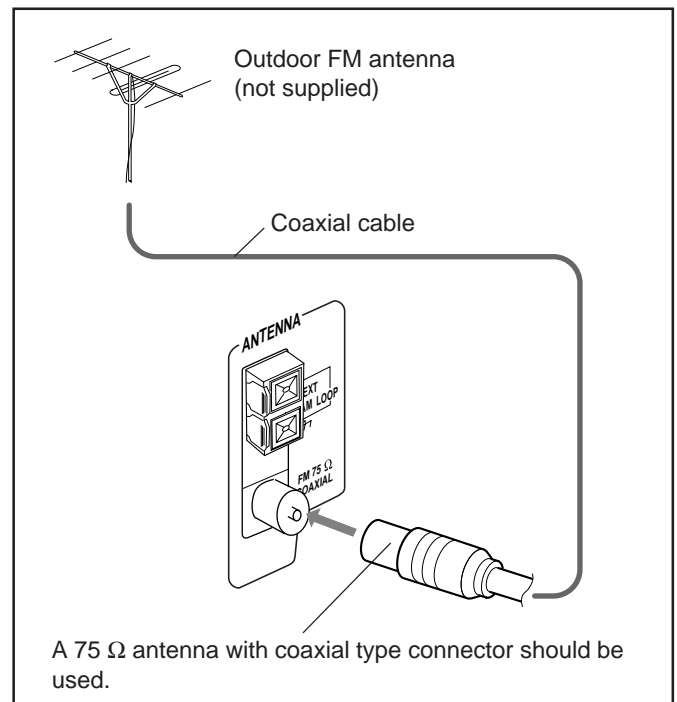

AM antenna

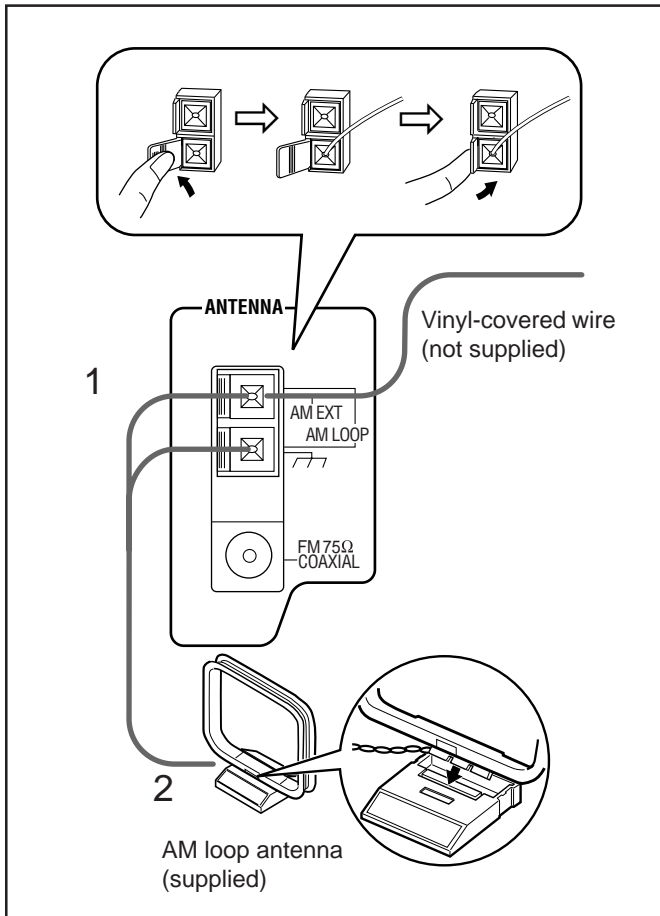

1 Connect the AM loop antenna to the AM LOOP terminals as illustrated.

- If the AM loop antenna wire is covered with vinyl, remove the vinyl by twisting it as shown in the diagram.

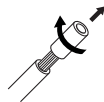

2 Turn the AM loop antenna until you have the best reception.

To connect an outdoor AM antenna

When reception is poor, connect a single vinyl-covered wire to the AM EXT terminal and extend it horizontally. (The AM loop antenna must remain connected.)



For better reception of both FM and AM

- Make sure the antenna conductors do not touch any other terminals and connecting cords.
- Keep the antennas away from metallic parts of the unit, connecting cords, and the AC power cord.

Connecting Speakers

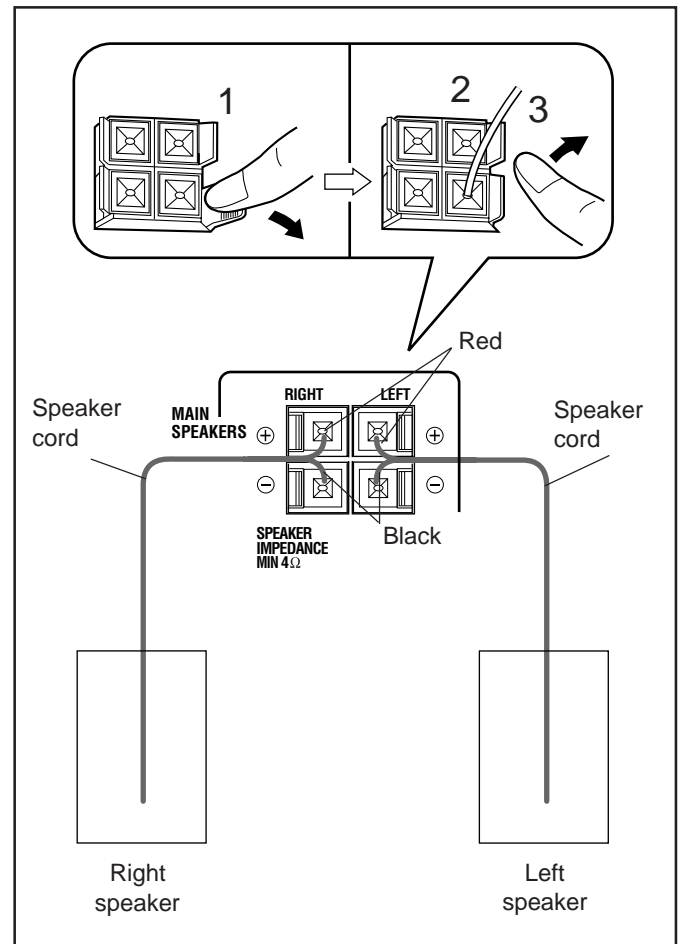

1 Press and hold the clamp of the speaker terminal on the rear of the unit.

2 Insert the end of the speaker cord into the terminal.

Match the polarity of the speaker terminals: Red (+) to red (+) and black (-) to black (-).

3 Release the finger from the clamp.

IMPORTANT: Use only speakers with the same speaker impedance as indicated by the speaker terminals on the rear of the unit.



Connecting Other Equipment

You can connect both of the analog and digital equipment.



- DO NOT connect any equipment while the power is on.
- DO NOT plug in any equipment until all connections are complete.

To connect audio equipment

Be sure that the plugs of the audio cords are colored: White plugs and jacks are for left audio signals, and red ones for right audio signals.

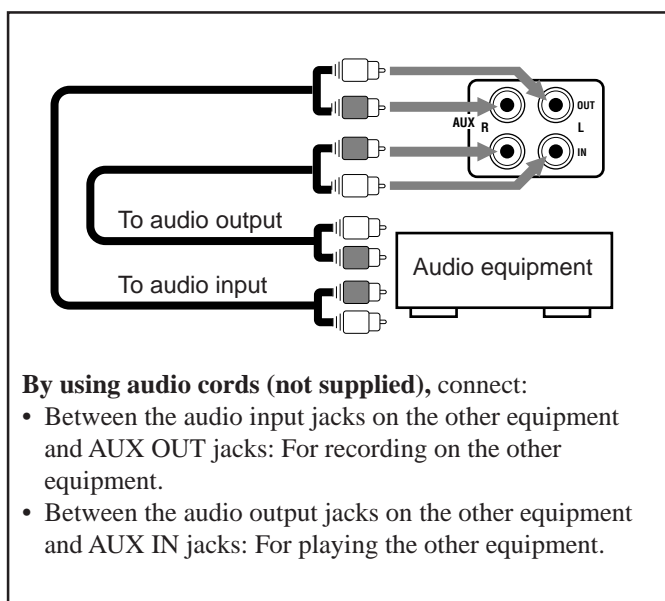

By using audio cords (not supplied), connect:

- Between the audio input jacks on the other equipment and AUX OUT jacks: For recording on the other equipment.
- Between the audio output jacks on the other equipment and AUX IN jacks: For playing the other equipment.

To connect audio equipment with an optical digital input terminal

You can record CD sound onto the connected digital equipment.

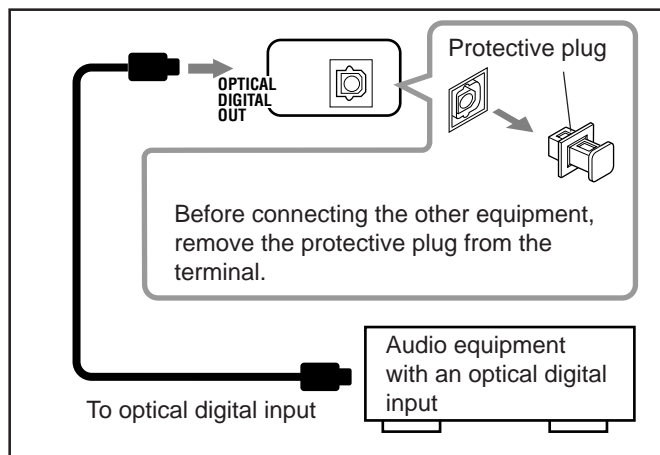

Connect an optical digital cord (not supplied) between the optical digital input terminal on the other equipment and the OPTICAL DIGITAL OUT terminal.

Now, you can plug the AC power cord.

IMPORTANT: Be sure to check all connections to be done before plugging the AC power cord into a wall outlet.

Common Operations

Turning On the Power

When you press the play button — CD ►/II, TAPE ◀▶, or the source selecting button — FM/AM, and AUX, the unit automatically turns on and starts playback if the source is ready.

To turn on the unit, press  (STANDBY/ON). The STANDBY lamp on the unit goes out.



To turn off the unit (on standby), press  (STANDBY/ON) again.

The STANDBY lamp lights up.

- The CLOCK indicator flashes on the display until you set the built-in clock. After setting the clock, the clock time will appear on the display while the power is off.
- A little power is always consumed even while the unit is on standby.

To switch off the power supply completely, unplug the AC power cord from the AC outlet.



When you unplug the AC power cord or if a power failure occurs

The clock is reset to “0:00” right away, while the tuner preset stations (see page 11) will be erased in a few days.

Setting the Clock

Before operating the unit any further, first set the clock built in this unit. When you plug the AC power cord into the wall outlet, the CLOCK indicator starts flashing on the display. You can set the clock whether the unit is on or off.

- There is a time limit in doing the following steps. If the setting is canceled before you finish, start from step 1 again.

On the unit ONLY:

1 Press CLOCK for more than 2 seconds.

The hour digits start flashing on the display.



2 Press ►► or ◀◀ to adjust the hour, then press CLOCK.

The minute digits start flashing on the display.

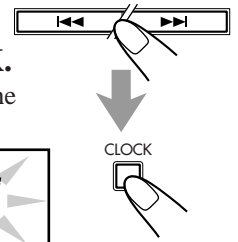

3 Press ►► or ◀◀ to adjust the minute, then press CLOCK.

The CLOCK indicator remains lit on the display.

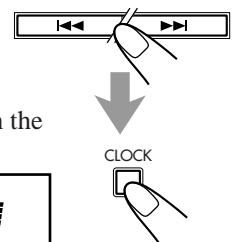

To check the clock time

Press DISPLAY on the remote control (or CLOCK on the unit) while playing any source.

- Each time you press the button, the source indication and the clock time alternate on the display.

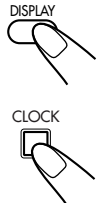



- When you unplug the AC power cord or if a power failure occurs, the clock loses the setting and is reset to “0:00.” You need to set the clock again.
- The clock may gain or lose 1 to 2 minutes per month.

Setting the AM Tuner Interval Spacing

When shipped, the AM tuner interval is set to 10 kHz or 9 kHz spacing. You can change it to 10 kHz or 9 kHz spacing.

On the unit ONLY:

To select 10 kHz intervals, while holding down ►► in standby mode, press  (STANDBY/ON) to turn on the power (at the same time, the 100 kHz spacing is selected for FM broadcast).

To select 9 kHz intervals, while holding down ◀◀ in standby mode, press  (STANDBY/ON) to turn on the power.

[10 kHz Intervals]

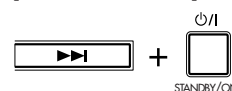

[9 kHz Intervals]

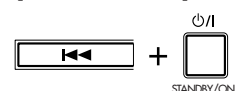

When you change the setting

The preset stations are erased. You will need to preset the stations again. (See page 11.)

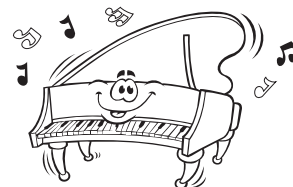

Selecting the Sources and Starting Play

To play back CDs, press CD ►/II. (See pages 12 – 14.)

To play back tapes, press TAPE ◀▶. (See page 15.)

To listen to the FM/AM broadcasts, press FM/AM. (See page 11.)

To select the external equipment as the source, press AUX.



Adjusting the Volume

You can adjust the volume level only while the unit is turned on. The volume level can be adjusted between “VOLUME 0” and “VOLUME40”.

When using the remote control, press VOLUME + to increase the volume or press VOLUME – to decrease it.

When using the unit, turn VOLUME + / – clockwise (+) to increase the volume or counterclockwise (–) to decrease it.

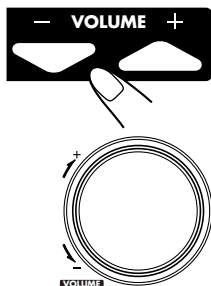

VOLUME 15



For private listening

Connect a pair of headphones to the PHONES jack. No sound comes out of the speakers. Be sure to turn down the volume before connecting or putting on headphones.



DO NOT turn off (on standby) the unit with the volume set to an extremely high level; otherwise, a sudden blast of sound can damage your hearing, speakers and/or headphones when you turn on the unit or start playing any source next time. REMEMBER you cannot adjust the volume level while the unit is on standby.

Reinforcing the Bass Sound

You can reinforce the bass sound to maintain rich (“AHB 1” and “AHB 2”), full bass at low volume. This function only affects the playback sound, but does not affect your recording.

To get the effect, press AHB (Active Hyper Bass) PRO until “AHB 1” or “AHB 2” appears on the display. The BASS indicator also lights up on the display.



- Each time you press the button, the bass sound change as follows:

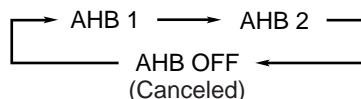

“AHB 2” has much more bass reinforcement effect than “AHB 1.”

To cancel the effect, press AHB PRO until “AHB OFF” appears on the display. The BASS indicator goes off.

Selecting the Sound Modes

You can select one of the 4 preset sound modes. This function only affects the playback sound, but does not affect your recording.

To select the sound modes, press SOUND MODE on the remote control (or SOUND on the unit) until the sound mode you want appears on the display. The SOUND indicator also lights up on the display.



- Each time you press the button, the sound modes change as follows:



ROCK: Gives a heavy sound. Boosts low and high frequency.

POP: Good for vocal music.

CLASSIC: Good for classical music.

JAZZ: Gives a feeling of live atmosphere. Good for acoustic music.

FLAT: The sound mode is canceled. The SOUND indicator goes off.

Listening to FM and AM Broadcasts



Tuning in a Station

1 Press FM/AM.

The unit automatically turns on and tunes in the previously tuned station (either FM or AM).

- Each time you press the button, the band alternates between FM and AM.



2 Press and hold ►► or ◄◄ for more than 1 second.

The unit starts searching for stations and stops when a station of sufficient signal strength is tuned in.

If a program is broadcast in stereo, the ST (stereo) indicator lights up.

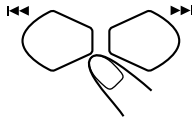

To stop searching, press ►► or ◄◄.



When you press ►► or ◄◄ briefly and repeatedly the frequency changes step by step.

To change the FM reception mode

When an FM stereo broadcast is hard to receive or noisy, press FM MODE on the remote control so that the MONO indicator lights up on the display. Reception improves.



To restore the stereo effect, press FM MODE again so that the MONO indicator goes off. In this stereo mode, you can hear stereo sounds when a program is broadcasted.

Presetting Stations

You can preset 30 FM and 15 AM stations — using either automatic presetting or manual presetting. In some cases, test frequencies have been already memorized for the tuner since the factory examined the tuner preset function before shipment. This is not a malfunction. You can preset the stations you want into memory by following the presetting method.

To preset stations automatically — Automatic Presetting

You need to preset stations separately for the FM and AM bands.

On the remote control ONLY:

1 Press FM/AM to select the band.

- Each time you press the button, the band alternates between FM and AM.



2 Press and hold AUTO PRESET for more than 2 seconds.

Local stations with strong signals are searched and stored in memory automatically.

When automatic presetting is over, the station stored in preset number 1 is received.



3 Repeat steps 1 and 2 to store stations for the other band.



When you cannot automatically store stations you want Stations with weak signals cannot be detected with this automatic presetting. To store such a station, use the manual presetting.

To preset stations manually — Manual Presetting

- There is a time limit in doing the following steps. If the setting is canceled before you finish, start from step 2 again.

On the remote control ONLY:

1 Tune in the station you want to preset.

- See “Tuning in a Station.”

2 Press SET.

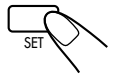

3 Press MULTI KEY > or MULTI KEY < to select a preset number.

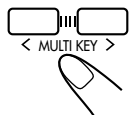
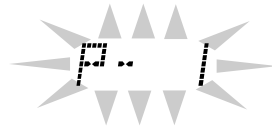

4 Press SET again.



The tuned station in step 1 is stored in the preset number selected in step 3.

- Storing a new station on a used number erases the previously stored one.



When you unplug the AC power cord or if a power failure occurs

The preset stations will be erased in a few days. If this happens, preset the stations again.

Tuning in a Preset Station

On the remote control ONLY:

1 Press FM/AM.

The unit automatically turns on and tunes in the previously tuned station (either FM or AM).

- Each time you press the button, the band alternates between FM and AM.



2 Press MULTI KEY > or MULTI KEY < to select a preset number.

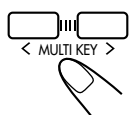

This unit has been designed to playback the following CDs:

- CD
- CD-R
- CD-RW

Continued use of irregular shape CDs (heart-shape, octagonal, etc.) can damage the unit.

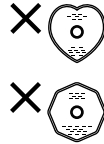

General Notes

In general, you will have the best performance by keeping your CDs and the mechanism clean.

- Store CDs in their cases, and keep them in cabinets or on shelves.
- Keep the unit's disc tray closed when not in use.

When playing a CD-R or CD-RW

User-edited CD-Rs (CD-Recordable) and CD-RWs (CD-ReWritable) can be played back only if they are already "finalized".

- You can play back your original CD-Rs or CD-RWs recorded in music CD format. (However, they may not be played back depending on their characteristics or recording conditions.)
- Before playing back CD-Rs or CD-RWs, read their instructions or cautions carefully.
- Some CD-Rs or CD-RWs may not be played back on this unit because of their disc characteristics, damage or stain on them, or if the player's lens is dirty.
- CD-RWs may require a longer readout time. (This is caused by the fact that the reflectance of CD-RWs is lower than for regular CDs.)

3 Press CD ►/II.

The disc tray automatically closes and the first track of the CD starts playing.

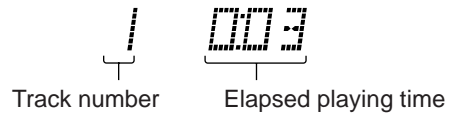

- The CD automatically stops when the last track of the CD has finished playing.

To stop playing, press ■.



To remove the disc, press CD ▲ on the remote control (or ▲ on the CD player section).



- **If the CD cannot be read correctly (because it is scratched, for example)**
"00 0000" appears on the display.
- **If no CD is inserted**
"NO DISC" appears on the display.
- **If an unreadable CD-R or CD-RW is inserted**
"BLANK CD" appears on the display.



DO NOT try to open or close the CD tray by hand as it will be damaged.

Playing Back the Entire CD — Normal Play

1 Press CD ▲ on the remote control (or ▲ on the CD player section).

The unit automatically turns on and the disc tray comes out.

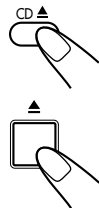

2 Place a disc correctly on the circle of the disc tray, with its label side up.

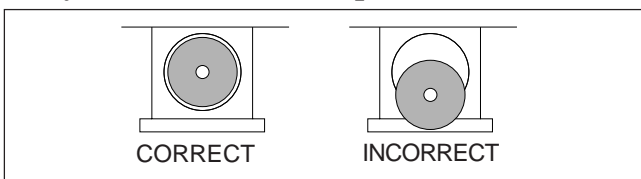

- When using a CD single (8 cm), place it on the inner circle of the disc tray.

Basic CD Operations

While playing a CD, you can do the following operations.

To stop playing for a moment

Press CD ►/II.

While pausing, the elapsed playing time flashes on the display.



To resume playing, press CD ►/II again.

To go to another track

Press MULTI KEY > / MULTI KEY < or ►►/◄◄ repeatedly before or during playback.



- MULTI KEY > or ►► : Skips to the beginning of the next or succeeding tracks.
- MULTI KEY < or ◄◄ : Goes back to the beginning of the current or previous tracks.

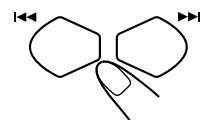

To locate a particular point in a track

During play, press and hold ►►| or ◄◄|.

- ►►| : Fast-forwards the tracks.
- ◄◄| : Fast-reverses the tracks.

Programming the Playing Order of the Tracks — Program Play

You can arrange the order in which tracks play before you start playing. **You can program up to 20 tracks.**

On the remote control ONLY:

1 Load a CD.

- If the current playing source is not the CD player, press CD ►/II, then ■ before going to the next step.

2 Press PROG (program).

The PRGM (program) indicator lights up on the display.



- If a program has been stored in memory, the program is called up.

3 Press MULTI KEY > or MULTI KEY < to select the track number, then press SET.

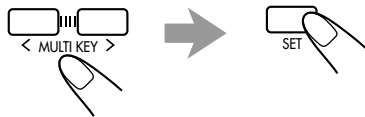

Track number Program step number

4 Repeat step 3 to program other tracks you want.

5 Press CD ►/II.

The tracks are played in the order you have programmed.



To stop playing, press ■.

To exit from Program play mode, press ■ before or after playing. The PRGM (program) indicator goes off. All the programmed tracks will be cleared.

- Disc ejection also erases the program.

To check the program contents

You can check the program contents by pressing PROG on the remote control. The programmed tracks are shown in the programmed order.



To modify the program

Before or after playing, you can erase the last programmed track by pressing CANCEL on the remote control.



- Each time you press the button, the last programmed track is erased from the program.

To add tracks in the program before playing, simply select the track numbers you want to add by following step 3 of the programming procedure.



- **If you try to program the 21st track**
"FULL" will appear on the display.
- **If the total playing time is 100 minutes or more**
The total playing time will not be shown. "--:--" will appear.



Playing at Random — Random Play

The tracks will play in no particular order when you use this mode.

On the remote control ONLY:

To use Random play mode, press RANDOM before or during playing.

The RANDOM indicator lights up on the display.



The tracks are played at random.

Random play ends when all the tracks are played once.

To skip the current track, press ►►1 or MULTI KEY >.

- You cannot go back to the previous track by pressing 1◄◄ or MULTI KEY <.

To stop playing, press ■.

- Random play mode is also canceled.

To exit from Random play mode, press RANDOM again before or during playing. Random play mode is canceled and Normal play resumes.

Repeating Tracks — Repeat Play

You can have all the tracks, the program or individual track currently playing to repeat as many times as you like.

On the remote control ONLY:

To repeat playing, press REPEAT before or during playing.

- Each time you press the button, Repeat play mode changes as follows, and the following indicator lights up on the display:

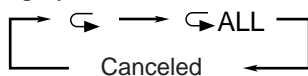

↶ : Repeats one track.

↶ALL : In Normal play mode, repeat all the tracks.

In Program play mode, repeat all the tracks in the program.

In Random play mode, repeats all the tracks in random order.

To stop playing, press ■.

To cancel Repeat play, press REPEAT repeatedly until the repeat indicator goes off from the display.

- In Random play ↶ cannot be selected. If ↶ is selected when you press RANDOM, it is canceled (goes off).
- Repeat mode remains in effect even when you change the play mode.

Prohibiting Disc Ejection — Tray Lock

You can lock the disc tray and prohibit to eject the CD.

- This is possible only while the unit is turned on.

On the unit ONLY:

To prohibit disc ejection, press ⏻/I (STANDBY/ON) while holding ■. (If the disc tray is opened, close it first.)

“LOCKED” appears for a while, and the disc tray is locked.

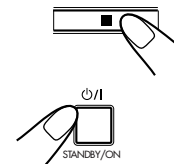

LOCKED

To cancel the prohibition and unlock the CD, press ⏻/I (STANDBY/ON) while holding ■.

“UNLOCKED” appears for a while, and the disc tray is unlocked.

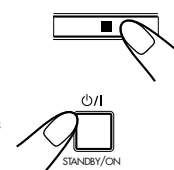

UNLOCKED



If you try to eject the CD,

“LOCKED” appears to inform you that the disc tray is locked.

Playing Back Tapes



You can play back type I, type II, and type IV tapes without changing any settings.

Playing Back a Tape

1 Press for cassette deck.

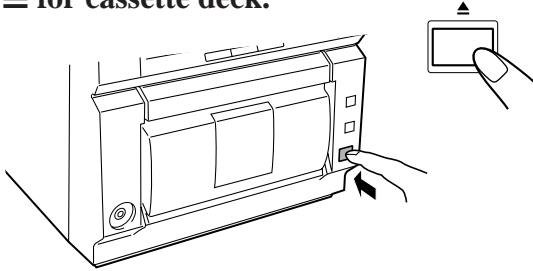

2 Put a cassette in with the exposed part of the tape down.

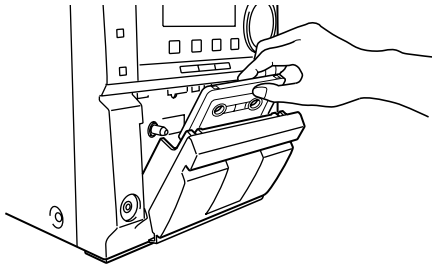

3 Close the cassette holder gently.

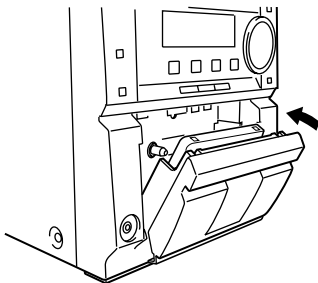

4 Press TAPE .

The unit automatically turns on and the tape play starts. The tape direction indicator (or) flashes slowly on the display.

• Each time you press the button, the tape direction changes.

- : plays the front side.
- : plays the reverse side.

When the tape plays to the end, the deck automatically stops if the reverse mode is set to or . (See “To play both sides — Reverse Mode.”)

To stop playing, press .

To fast-wind to the left or to the right, press or while the tape is not running.

The tape direction indicator (or) starts flashing quickly on the display.

To remove the cassette, press for cassette deck.

To play both sides — Reverse Mode

You can set the deck to play just one side of a tape, both sides once, or both sides continuously.

Press REV.MODE on the unit.

- Each time you press the button, reverse mode changes as follows:

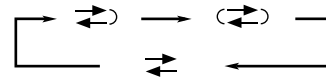

- : The deck automatically stops after playing both sides of the tape. (Stops when playback in the direction is finished.)
- : The deck continues to play both sides of the tape until is pressed.
- : The deck automatically stops after playing one side of the tape.



The use of the C-120 or thinner tape is not recommended, since characteristic deterioration may occur and this tape easily jams in the pinch-rollers and the capstans.

IMPORTANT:

- It may be unlawful to record or play back copyrighted material without the consent of the copyright owner.
- The recording level is automatically set correctly, so it is not affected by the VOLUME, AHB (Active Hyper Bass) PRO, and SOUND MODE settings. Thus, during recording you can adjust the sound you are actually listening to without affecting the recording level.
- If recordings you have made have excessive noise or static, the unit may be too close to a TV. Increase the distance between the TV and the unit.
- You can use type I tape for recording.

To protect your recording

Cassettes have two small tabs on the back to protect from unexpected erasure or re-recording.

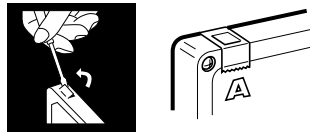

To protect your recording, remove these tabs.

To re-record on a protected tape, cover the holes with adhesive tape.

To keep the best recording and playback sound quality

If the heads, capstans, and pinch rollers of the cassette decks become dirty, the following will occur:

- Impaired sound quality
- Discontinuous sound
- Fading
- Incomplete erasure
- Difficulty in recording

To clean the heads, capstans, and pinch rollers

Use a cotton swab moistened with alcohol.

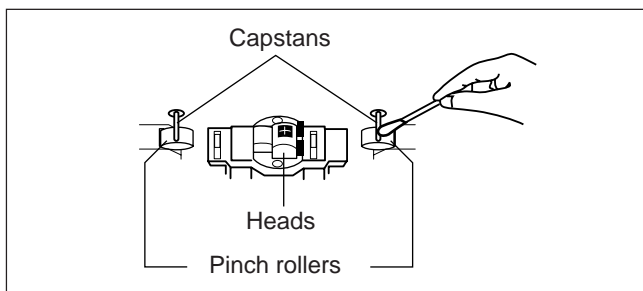

To demagnetize the heads

Turn off the unit, and use a head demagnetizer (available at electronics and audio shops).



At the start and end of cassette tapes

There is leader tape which cannot be recorded onto. Thus, when recording CDs or radio broadcasts, wind the leader tape first to ensure that the recording will be made without any music part lost.

Recording on a Tape

On the unit ONLY:

- 1 Put a recordable cassette in with the exposed part of the tape down.

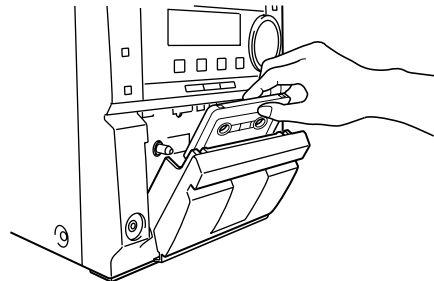

- 2 Close the cassette holder gently.

- If you want to record on both sides of a tape, see “To record on both sides — Reverse Mode.”

- 3 Check the recording direction for the tape.

- If the tape direction is not correct, press TAPE ◀▶ twice then ■ to change the tape direction.

- 4 Start playing the source — FM, AM or auxiliary equipment connected to AUX jacks.

- When the source is CD, see “CD Direct Recording” on page 17.

- 5 Press REC.

The REC indicator lights up on the display and recording starts.



To stop recording, press ■.

To remove the cassette, press ▲ for cassette deck.

To record on both sides — Reverse Mode

Press REV.MODE on the unit until the ↔ indicator is lit.



- When using the reverse mode for recording, start recording in the forward (▶) direction first. Otherwise, recording will stop when recording is done only on one side (reverse) of the tape.



CD Direct Recording

Everything on the CD goes onto the tape in the order it is on the CD, or according to the order you have made for Program play.

On the unit ONLY:

- 1 Put a recordable cassette in with the exposed part of the tape down.

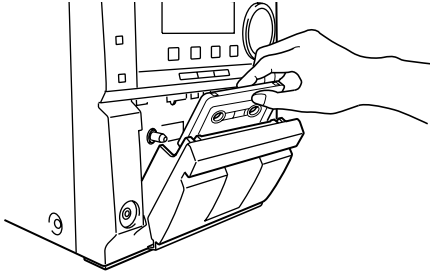

- 2 Place a disc correctly on the circle of the disc tray, with its label side up.

- If the current playing source is not the CD player, press CD ►/||, then ■ before going to the next step.
- If you want to record on both sides of a tape, see “To record on both sides — Reverse Mode.”
- If you do not want pauses of about 4 seconds recorded between selections, press CD ►/|| twice. If nothing is done, non-recorded pause will be automatically recorded between selections.

- 3 Press REC.

The REC indicator lights up on the display and recording starts.

After recording, the CD player and cassette deck automatically stop.



To stop CD Direct Recording, press ■. The tape stops after 4 seconds.

To remove the cassette, press ▲ for the cassette deck.

To record on both sides — Reverse Mode

Press REV.MODE on the unit until the ↺ indicator is lit.



- When using the reverse mode for CD Direct Recording, start recording in the forward (►) direction first. When the tape reaches its end while recording a song in the forward direction (►), the last song will be re-recorded at the beginning of the reverse side (◄).

If you start recording on the reverse side (◄), recording will stop when recording is done only on one side (reverse) of the tape.



When making SLEEP timer settings while doing CD Direct recording

Set enough time to allow for the CD to finish playing; otherwise the power will go off before recording is completed.

One Track Recording

This recording method is convenient when you record tracks while playing a CD. You can only record your favorite songs on the tape.

On the unit ONLY:

- 1 Put a recordable cassette in with the exposed part of the tape down.

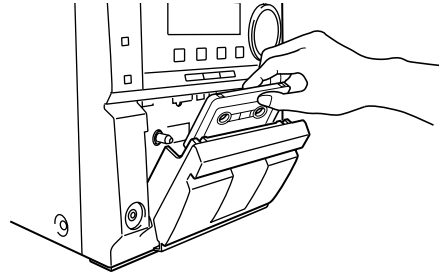

- 2 Play the track on the CD you wish to record.

- 3 Press REC.

The CD player returns to the beginning of that track and the track is recorded on the tape. After recording, the CD player and cassette deck automatically stop.



- 4 Repeat steps 2 and 3 to record other tracks you want.

There are three timers available — Daily Timer, Recording Timer, and Sleep Timer.

Before using the timers, you need to set the clock built in the unit (see page 9.) When you press **TIMER** on the unit for more than 3 seconds, the display alternates between “ADJUST” and “CLOCK” for about 5 seconds.

Using Daily Timer and Recording Timer

You can set the timer whether the unit is on or off.

When the on-time comes, the unit automatically turns on (the  indicator flashes just before the on-time, and continues flashing while the timer is operating.) Then, when the off-time comes, the unit automatically turns off (on standby).

The timer setting remains in memory until you change it.

- When the **DAILY** indicator is lit on the display, the timer acts as the Daily Timer. Once the Daily Timer has been set, it will be activated at the same time everyday until the timer is turned off.
- When the **REC** indicator is lit on the display, the timer acts as the Recording Timer. After the Recording Timer has been performed, the details of the setting remain stored but the timer is turned off.

Before you start...

When using “TUNER” as the source to play, make sure to select the desired station before turning off the power.

- There is a time limit in doing the following steps. If the setting is canceled before you finish, start from step 1 again.

On the unit ONLY:

1 Press and hold **TIMER** for more than 3 seconds.

The timer () indicator lights up, and the timer mode indicator (**DAILY** or **REC**) and the current on-time flash on the display. The unit enters on-time setting mode.



2 Set the on-time you want the unit to turn on at.

- 1) Press **▶▶** or **◀◀** to set the hour, then press **TIMER**.
- 2) Press **▶▶** or **◀◀** to set the minute, then press **TIMER**.
The unit enters off-time setting mode.

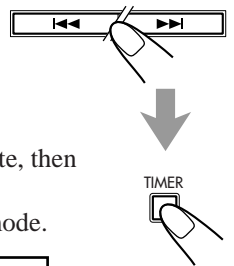
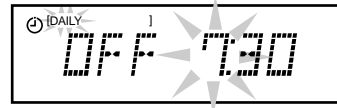

3 Set the off-time you want the unit to turn off (on standby) at.

- 1) Press **▶▶** or **◀◀** to set the hour, then press **TIMER**.
- 2) Press **▶▶** or **◀◀** to set the minute, then press **TIMER**.
The unit enters source selecting mode.

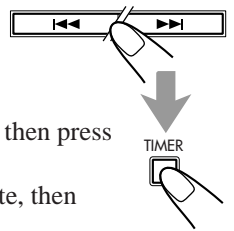

4 Press **▶▶** or **◀◀** to select the timer mode (Daily Timer or Recording Timer) and the source to play, then press **TIMER**.

- Each time you press **▶▶** or **◀◀**, the timer mode and the source change as follows:

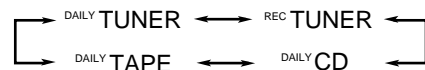

DAILY TUNER: tunes into the last station you were listening to. (Daily Timer)

REC TUNER: records the last station you were listening to. (Recording Timer)

- Put a recordable cassette into the deck.

DAILY CD: plays a CD. (Daily Timer)

DAILY TAPE: plays a tape. (Daily Timer)

- Make sure that the tape direction is correct.

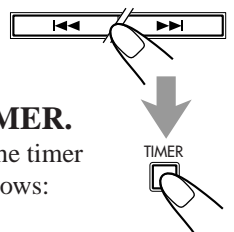

5 Press **▶▶** or **◀◀** to set the volume level.

- You can select the volume level (“VOLUME 0” to “VOLUME40” and “VOLUME –”). If you select “VOLUME –,” the volume is set to the last level when the unit has been turned off.

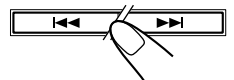

To turn off the volume while the Recording Timer (REC TUNER) is working, set the volume level “VOLUME 0.”



6 Press **TIMER** to complete the timer setting.



7 Press **⏻/I** (**STANDBY/ON**) to turn off the unit (on standby) if you have set the timer with the unit turned on.

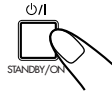

- When the timer turns on the unit, the timer (⌚) indicator and the selected timer mode indicator (DAILY or REC) start flashing.

To cancel the setting, press and hold **TIMER** until the timer (⌚) indicator goes off from the display.



- **If the unit is turned on when the timer-on time comes**
Timer does not work.
- **When you unplug the AC power cord or if a power failure occurs**
The timer will be canceled. You need to set the clock first, then the timer again.

Using Sleep Timer

With Sleep Timer, you can fall asleep to music. You can set Sleep Timer when the unit is turned on.

How Sleep Timer actually works

The unit automatically turns off after the specified time length passes.

On the remote control ONLY:

1 Press SLEEP.

The time length until the shut-off time appears and the SLEEP indicator lights up on the display.



- Each time you press the button, the time length changes as follows:

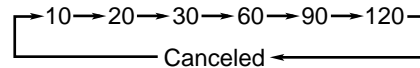

2 Wait for about 5 seconds after specifying the time length.

To check the remaining time until the shut-off time, press SLEEP once so that the remaining time until the shut-off time appears for about 5 seconds.

To change the shut-off time, press SLEEP repeatedly until the desired time length appears on the display.

To cancel the setting, press SLEEP repeatedly until the SLEEP indicator goes off.

- Sleep Timer is also canceled when you turn off the unit.



- **If you set the Sleep Timer after Daily Timer starts playing the selected source**
Daily Timer is canceled.
- **If you set the Sleep Timer after Recording Timer starts recording**
Recording Timer is canceled, but recording continues until Sleep Timer shuts off the power.



To get the best performance of the unit, keep your discs, tapes, and mechanism clean.

Handling discs



- Remove the disc from its case by holding it at the edge while pressing the center hole lightly.
- Do not touch the shiny surface of the disc, or bend the disc.
- Put the disc back in its case after use to prevent warping.

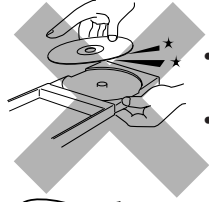

- Be careful not to scratch the surface of the disc when placing it back in its case.
- Avoid exposure to direct sunlight, temperature extremes, and moisture.



To clean the disc

Wipe the disc with a soft cloth in a straight line from center to edge.

Cleaning the unit

• Stains on the unit

Should be wiped off with a soft cloth. If the unit is heavily stained, wipe it with a cloth soaked in water-diluted neutral detergent and wrung well, then wipe clean with a dry cloth.

• Since the unit may deteriorate in quality, become damaged or get its paint peeled off, be careful about the followings.

- DO NOT wipe it with a hard cloth.
- DO NOT wipe it strong.
- DO NOT wipe it with thinner or benzine.
- DO NOT apply any volatile substance such as insecticides to it.
- DO NOT allow any rubber or plastic to remain in contact with it for a long time.



DO NOT use any solvent — such as conventional record cleaner, spray, thinner, or benzine — to clean the disc.

Handling cassette tapes

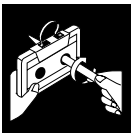

- If the tape is loose in its cassette, take up the slack by inserting a pencil in one of the reels and rotating.
- If the tape is loose, it may get stretched, cut, or caught in the cassette.



- Be careful not to touch the tape surface.



- Avoid the following places to store the tape:
 - In dusty places
 - In direct sunlight or heat
 - In moist areas
 - On a TV or speaker
 - Near a magnet

Troubleshooting



If you are having a problem with your unit, check this list for a possible solution before calling for service.

If you cannot solve the problem from the hints given here, or the unit has been physically damaged, call a qualified person, such as your dealer, for service.

Symptom	Cause	Action
No sound is heard.	<ul style="list-style-type: none"> • Connections are incorrect or loose. • Headphones are connected. 	<ul style="list-style-type: none"> • Check all connections and make corrections. (See pages 6 to 8.) • Disconnect the headphones.
Hard to listen to broadcasts because of noise.	<ul style="list-style-type: none"> • Antennas are disconnected. • The AM loop antenna is too close to the unit. • The FM antenna is not properly extended and positioned. 	<ul style="list-style-type: none"> • Reconnect the antennas correctly and securely. • Change the position and direction of the AM loop antenna. • Extend the FM antenna at the best position.
The disc tray does not open or close.	The AC power cord is not plugged in.	Plug the AC power cord.
The disc does not play.	The disc is placed upside down.	Place the disc with the label side up.
The disc sound is discontinuous.	The disc is scratched or dirty.	Clean or replace the disc. (See page 20.)
The cassette holder cannot be opened.	Power supply from the AC power cord has been cut off while the tape was running.	Turn on the unit.
Impossible to record.	Small tabs on the back of the cassette are removed.	Cover the holes with adhesive tape.
Operations are disabled.	The built-in microprocessor may malfunction due to external electrical interference.	Unplug the AC power cord and then plug it back in.
Unable to operate the unit from the remote control.	<ul style="list-style-type: none"> • The path between the remote control and the remote sensor on the unit is blocked. • The batteries are exhausted. 	<ul style="list-style-type: none"> • Remove the obstruction. • Replace the batteries.

Specifications

Design and specifications are subject to change without notice.

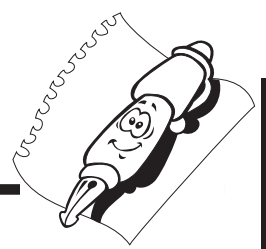

UX-P3 (CA-UXP3 and SP-UXP3)

Amplifier

Output Power:

44 W (22 W + 22 W) at 4 Ω (MAX.)

40 W (20 W + 20 W) at 4 Ω (10 % THD)

Audio input sensitivity/Impedance (at 1 kHz)

AUX: 400 mV/48 k Ω

Audio output level

AUX: 260 mV/5.8 k Ω

Digital output — OPTICAL DIGITAL OUT

Signal wave length: 660 nm

Output level: -21 dBm to -15 dBm

Speakers/Impedance: 4 Ω – 16 Ω

Tuner

FM tuning range: 87.50 MHz – 108.00 MHz

AM tuning range:

At 9 kHz intervals : 531 kHz – 1 710 kHz

At 10 kHz intervals : 530 kHz – 1 710 kHz

CD player

Dynamic range: 85 dB

Signal-to-noise ratio: 90 dB

Wow and flutter: Immeasurable

Cassette deck

Frequency response

Normal (type I): 50 Hz – 14 000 Hz

Wow and flutter: 0.15 % (WRMS)

General

Power requirement: AC 230 V \sim , 50 Hz

Power consumption: 50 W (at operation)

4.2 W (on standby)

Dimensions (approx.): 505 mm x 256 mm x 295 mm (W/H/D)

Mass (approx.): 8.5 kg

Supplied Accessories

See page 6.

Speaker

Speaker units: 8 cm cone x 1

Impedance: 4 Ω

Dimensions (approx.): 160 mm x 256 mm x 205 mm (W/H/D)

Mass (approx.): 2.1 kg

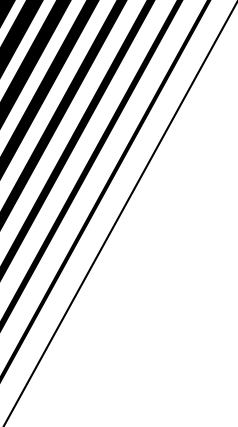

JVC
VICTOR COMPANY OF JAPAN, LIMITED